

High-Pressure Atomizing System

PRODUCT CATALOG

DRISTEEM[®]
The humidification experts



Energy-efficient humidification

Reduces cooling load

Reduces water waste

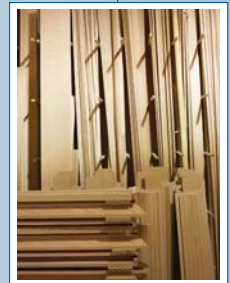

Advanced, efficient humidification

DRI-STEEM High-Pressure Atomizing System installed in an air handler



Pure pressurized water and micro-turbine injection nozzles

The DRI-STEEM® High-Pressure Atomizing System provides high-quality, industrial-grade humidification solutions suitable for a wide variety of applications.

The system's high-pressure pump propels purified, unheated water past a small turbine inside each dispersion nozzle. This fragments water droplets into ultra-fine particles that quickly absorb in warm air-handler airstreams or open spaces.

Energy-efficient humidification

DRI-STEEM's High-Pressure Atomizing System uses heat already present in air to evaporate evenly-distributed water droplets. In warm, dry applications, atomization is the most energy-efficient humidification system.

Reduces cooling load

As atomized water droplets are absorbed (evaporation), air temperature drops, reducing the cooling load. This provides significant energy savings when cooling and humidifying simultaneously.

Reduces water waste

The system's advanced controller monitors multiple conditions to modulate and control nozzle operation. This optimizes absorption and minimizes water waste.

The benefits of humidification

- Improve indoor air quality
- Improve manufacturing processes
- Preserve materials and furnishings
- Improve comfort for building occupants

DRI-STEEM High-Pressure Atomizing System installed in an open space



Features and benefits

The most-advanced adiabatic technology

- Water under pressure (up to 1200 psi) delivered to hi-tech dispersion nozzles; no pressurized air required
- Stainless-steel pump requires no maintenance because it is cooled by purified humidification supply water
- Integral check valve inside nozzle ensures no dripping when system shuts off
- Nozzles have micro-turbines that fragment water droplets into ultra-fine particles (ten microns or less)
- Mist eliminator installed five feet or more downstream from heating coil prevents wetting farther downstream
- Extremely low installation and operation costs
- Humidifies in air handlers or open spaces
- System capacities from 250 to 8500 lbs/hr

Cooling effect saves energy

- Every pound of atomized humidification removes approximately 1000 Btus of heat from the air
- Significant HVAC system energy savings occurs when cooling and humidifying simultaneously
- Utility rebates can offset costs

Control system optimizes absorption

- Algorithmic controller and sensors monitor multiple conditions
- Atomizing nozzles sized and manifolds configured per application requirements
- Nozzle staging and pulsed modulation allow high turndown of system output
- Remote assistance and diagnostic capability via internet or building automation network
- Modbus® (standard) and BACnet® interoperability
- Easy-to-use, full-color LCD touchscreen display

Multiple zone humidification from one system

- Generate humidification for multiple zones with one system
- Control multiple zones independently with one controller

Complete solution including water treatment

- System includes reverse osmosis hyperfiltration, particulate filtering, dechlorination, and duplex water softening
- Thorough water filtration protects stainless-steel components from corrosion and undue wear
- Automatic back-flush technology ensures long RO-membrane life
- Ultra-pure humidification eliminates white dust fallout and bacteria/virus proliferation that can occur when using potable water

Nozzle component detail

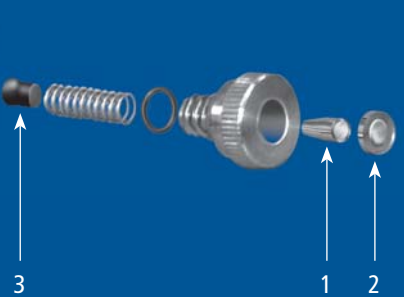

- 1 High-pressure water flows past a micro-turbine, breaking water into fine particles.
- 2 Water exits calibrated nozzle orifice, where water particle size reduces further to 10 microns or less.
- 3 Integral check-valve eliminates dripping when nozzle shuts off.

System overview

DRI-STEEM High-Pressure Atomizing System: A complete system that includes water treatment

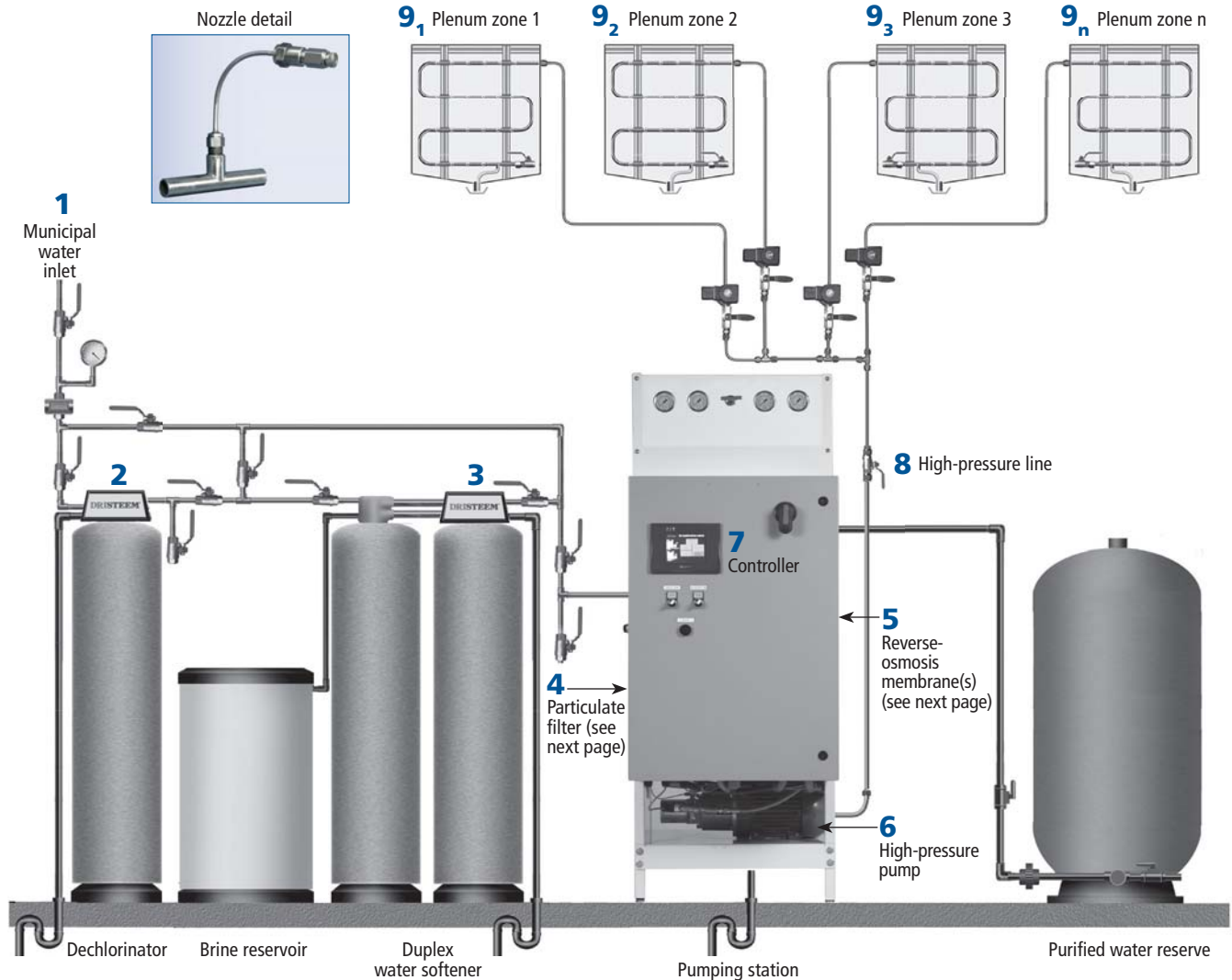

Sequence of operation

- 1 Water enters humidification system from municipal water supply and travels to:
- 2 Dechlorinator (located within pumping station on smaller models)
- 3 Duplex water softener
- 4 Particulate filter (located within pumping station)
- 5 Reverse-osmosis membrane(s)
- 6 All-stainless-steel axial-piston high-pressure pump delivers purified high-pressure water to atomizing nozzles
- 7 One control system optimizes absorption in multiple humidification zones
- 8 Main water line feeds network of high-pressure stainless-steel piping
- 9 Micro-turbine nozzles disperse purified, ultra-fine water droplets into AHUs and/or open spaces
- 10 Mist eliminator (not shown) installed downstream of AHU heating coil prevents wetting farther downstream

Pumping station components

Pumping station ships fully assembled and ready for power and water supply connections

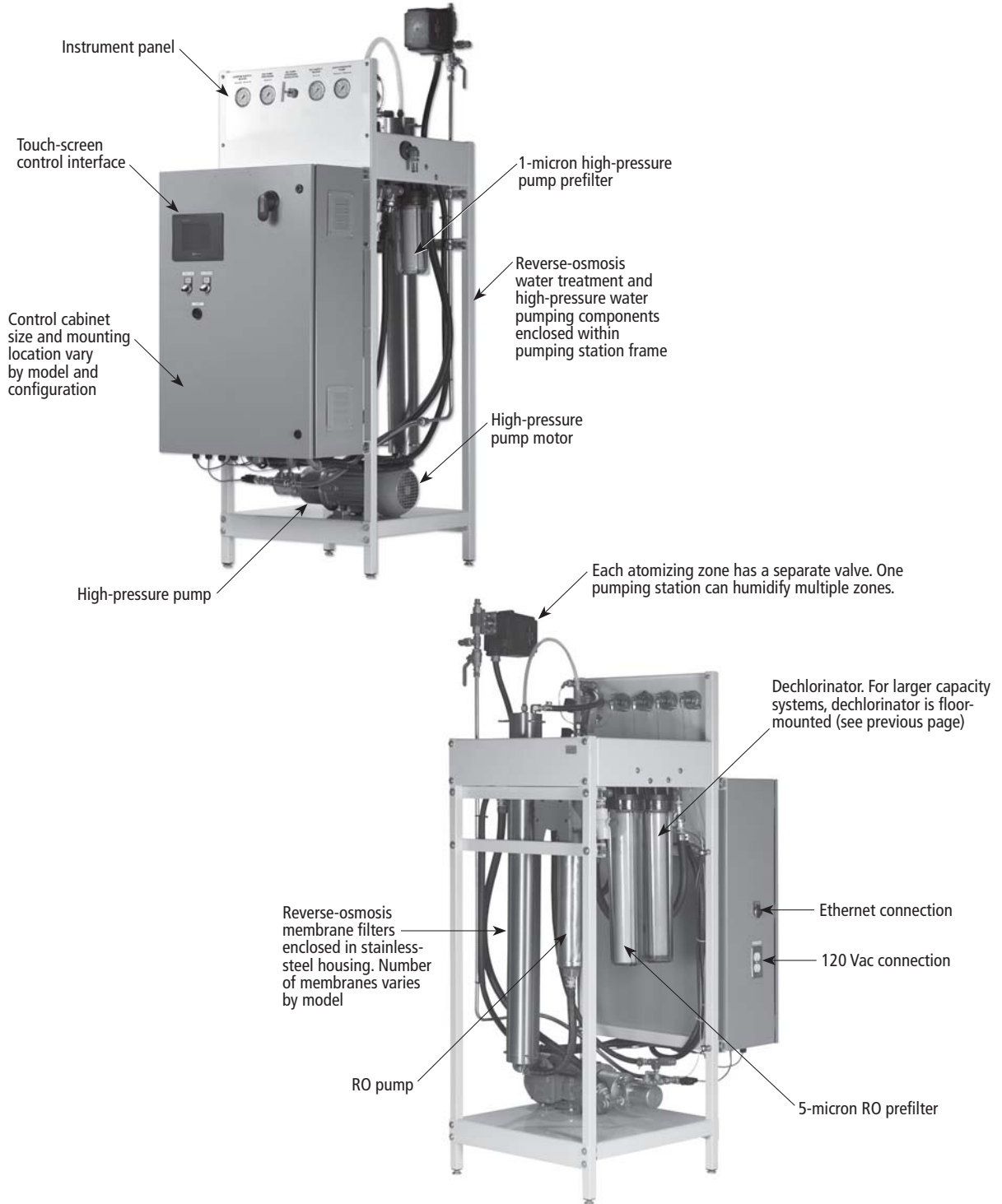

Note:
Model 500 shown. Components and configurations may vary to meet application requirements.

Pumping station specifications

**Table 6-1:
Pumping station specifications**

Model	250	500	1000	1500	2000	2500	3500	5000	6500	8500
System capacity (lbs/hr)	250	500	1000	1500	2000	2500	3500	5000	6500	8500
Max. system voltage/ phase, Amp draw	220/1, 10.6 480/3, 2.8 600/3, 2.2	220/1, 16.6 480/3, 4.4 600/3, 3.6	220/1, 21.9 480/3, 5.8 600/3, 4.7	220/1, 30.6 480/3, 8.1 600/3, 6.6	480/3, 10.9 600/3, 8.9	480/3, 13.5 600/3, 11.0	480/3, 19.7 600/3, 16.0	480/3, 26.5 600/3, 21.5	480/3, 38.2 600/3, 31.1	480/3, 46.5 600/3, 37.8
Pumping station dimensions inches (w × d × h)	24 × 24 × 56	24 × 24 × 56	24 × 24 × 56	24 × 24 × 66	24 × 24 × 66	32 × 24 × 66	32 × 32 × 66	72 × 24 × 60	72 × 24 × 60	72 × 24 × 60
Pumping station weight (lbs)	350	450	500	650	750	800	1000	1200	1500	1800
Supply water connection 25 psi min. (dia., inches) †	¾	¾	¾	1	1	1	1 ½	1 ½	1 ½	2
5-micron RO prefilter inches (dia. × h) *	2.5 × 20	2.5 × 20	2.5 × 20	4 × 20	4 × 20	4 × 20	4 × 20	4 × 20	4 × 20	4 × 20
RO pump flow rate (gpd) *	600	1500	3000	4500	6000	7500	10500	15000	20000	25000
RO pump motor (hp) *	0.5	1.5	1.5	3	3	5	7.5	10	15	20
RO pump motor (rpm) *	3600	3600	3600	3600	3600	3600	3600	3600	3600	3600
RO membranes (number) *	1	1	2	3	4	1	2	3	4	5
RO membrane size inches (dia. × h) *	4 × 20	4 × 4.0	4 × 40	4 × 40	4 × 40	8 × 40	8 × 40	8 × 40	8 × 40	8 × 40
1-micron high-pressure pump prefilter inches (dia. × h) **	2.5 × 10	2.5 × 10	2.5 × 20	4 × 20	4 × 20	4 × 20	4 × 20	4 × 20	4 × 20	4 × 20
High-pressure water (post-RO) pump flow rate (gpm) **	0.5	1.0	2.0	3.0	4.0	5	7	10	13	17
High-pressure water (post-RO) pump motor (hp) **	0.75	1.5	2	3	5	5	7.5	10	15	15
High-pressure water (post-RO) pump motor (rpm) **	1800	1800	1800	1800	1800	1800	1800	1800	1800	1800
* Reverse-osmosis water treatment components include: Multistage pump with all-stainless-steel body and wetted parts TEFC high-efficiency motor Start/stop stainless-steel pressure transmitter (30-50 psig) Water inlet low-pressure detection (3-10 psig) Water supply solenoid valve, 24 Vac, brass body RO pressure gauge, 0-400 psig, stainless steel, 2.5" dia., panel mounted Pure water tank pressure gauge, 0-100 psig, stainless steel, 2.5" dial, panel mounted Water inlet pressure gauge, 0-160 psig, stainless steel, 2.5" dia., panel mounted Pure-water tank pressure safety valve, 75 psig, tank mounted 5-micron RO prefilter with purge and cut-off valve Reject flow control pressure regulator, brass body Automatic membrane fast flush † 25 psi minimum water supply pressure required at inlet to pumping station					** High-pressure water and pumping station components include: High-pressure, all-316-stainless-steel, quintuple-axial-piston pump, water cooled, water lubricated, maintenance free Direct-coupled pump motor, TEFC, heavy duty, high torque, 1800 rpm Pressure regulator with flow leak detection, stainless-steel wearing parts, calibrated between 500-1200 psig, front mounted Stainless-steel pressure gauge, 0-1500 psig, 2.5" dia., front mounted 1-micron high-pressure pump prefilter Thermal protection sensor, pump mounted Low-pressure switch, pump mounted Hydraulic vibration damper Leveling and anti-vibration legs Modular steel frame with epoxy-powder-coated finish RO water treatment components are integrated into pumping station framework					

System dimensions

Figure 7-1:
DRI-STEEM High-Pressure Atomizing System dimensions

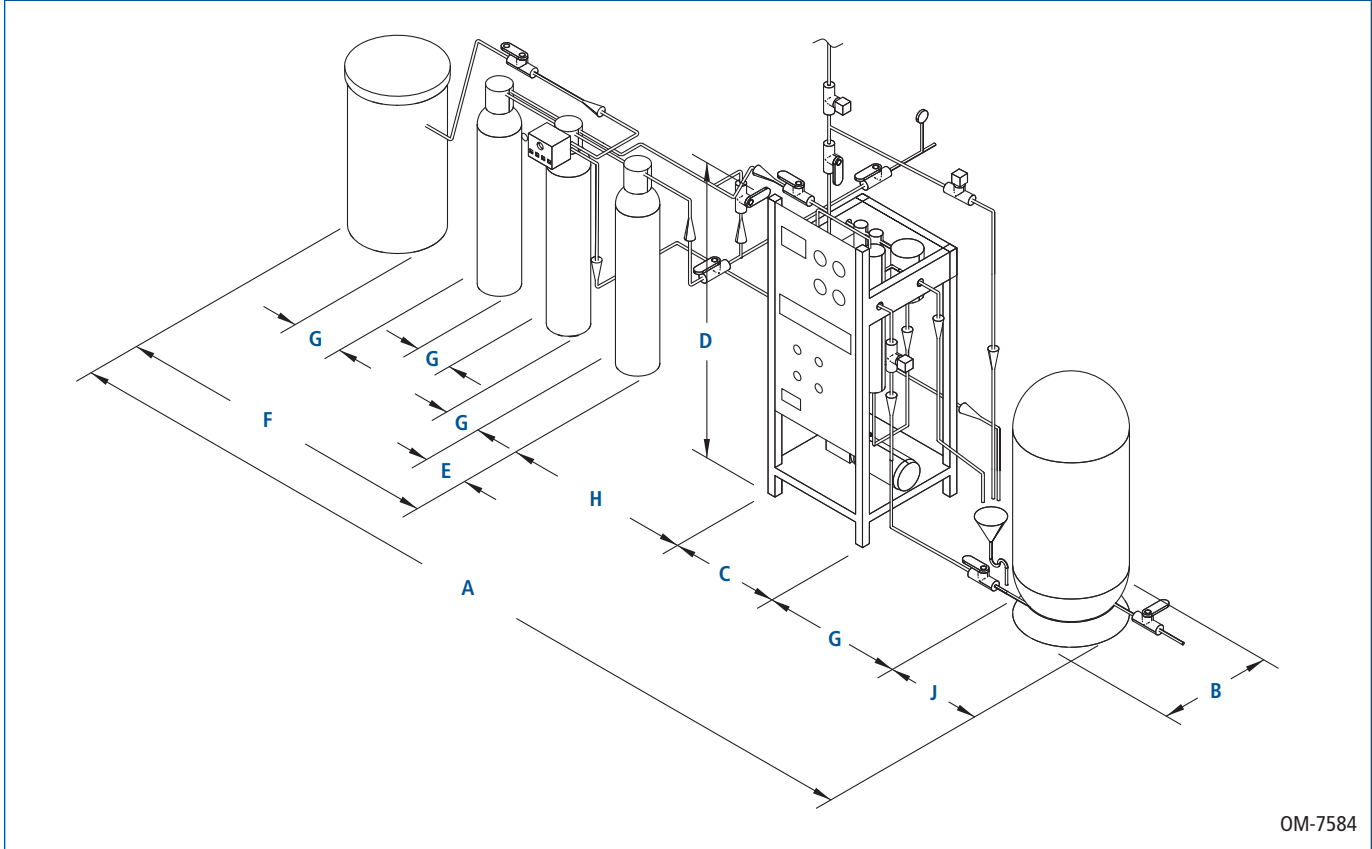

OM-7584

Table 7-1:
DRI-STEEM High-Pressure Atomizing System dimensions

Model	Dimension																	
	A*		B		C		D		E**		F**		G***		H		J	
	inches	mm	inches	mm	inches	mm	inches	mm	inches	mm	inches	mm	inches	mm	inches	mm	inches	mm
250	112	2845	24	610	24	610	56	1422	10	254	46	1168	4	102	10	254	24	610
500	112	2845	24	610	24	610	56	1422	10	254	46	1168	4	102	10	254	24	610
1000	116	2946	24	610	24	610	56	1422	12	305	50	1270	4	102	10	254	24	610
1500	116	2946	24	610	24	610	66	1676	12	305	50	1270	4	102	10	254	24	610
2000	120	3048	24	610	24	610	66	1676	16	406	54	1372	4	102	10	254	24	610
2500	128	3251	24	610	32	813	66	1676	16	406	54	1372	4	102	10	254	24	610
3750	128	3251	32	813	32	813	66	1676	16	406	54	1372	4	102	10	254	24	610
5000	120	3048	72	1829	24	610	60	1524	16	406	54	1372	4	102	10	254	24	610
6500	120	3048	72	1829	24	610	60	1524	16	406	54	1372	4	102	10	254	24	610
8500	120	3048	72	1829	24	610	60	1524	16	406	54	1372	4	102	10	254	24	610

Notes:

* Overall dimension depends on system configuration.

** Water treatment and reservoir dimensions depend on water quality and system size. Dimension may be smaller.

*** Minimum

Conserving resources through better performance

Expect quality from the industry leader

For more than 45 years, DRI-STEEM has been leading the industry with creative and reliable humidification solutions. Our focus on quality is evident in the construction of the DRI-STEEM High-Pressure Atomizing System, which features cleanable, stainless steel construction. DRI-STEEM also leads the industry with a Two-year Limited Warranty and optional extended warranty.

For more information

www.dristeem.com
sales@dristeem.com

For the most recent production information visit our web site:

www.dristeem.com

DRI-STEEM Corporation

An ISO 9001:2000 certified company

U.S. Headquarters:
14949 Technology Drive
Eden Prairie, MN 55344
800-328-4447 or 952-949-2415
952-229-3200 (fax)

European office:
Marc Briers
Grote Hellekensstraat 54 b
B-3520 Zonhoven
Belgium
+3211823595 (voice)
+3211817948 (fax)
E-mail: marc.briers@dristeem.com

Continuous product improvement is a policy of DRI-STEEM Corporation; therefore, product features and specifications are subject to change without notice.

DRI-STEEM, Ultra-sorb, and Vapor-logic are registered trademarks of DRI-STEEM Corporation and are filed for trademark registration in Canada and the European community.

Product and corporate names used in this document may be trademarks or registered trademarks. They are used for explanation only without intent to infringe.

Ultra-sorb is covered by the following Patents, with additional patents pending: United States Patent numbers 5,126,080; 5,277,849; 5,372,753; 5,376,312; 5,543,090

© 2010 DRI-STEEM Corporation



Form No. HPAS-CAT-0310

DRI-STEEM conserves resources by designing humidification systems that optimize performance. Systems that perform well save energy and water and, ultimately, cost less to operate and maintain.

Save energy

For applications requiring short absorption, high-efficiency dispersion tubes reduce wasted energy up to 85% by significantly reducing airstream heat gain and condensate production. Available for new and retrofit Ultra-sorb® and Rapid-sorb® steam dispersion panels.

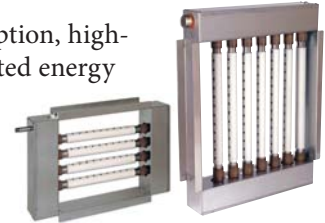

For warm, dry applications, DRI-STEEM's High-Pressure Atomizing System disperses unheated micro-fine water particles into airstreams or open spaces. As atomized water droplets evaporate, air temperature drops, reducing the cooling load. This provides significant energy savings when humidifying and cooling simultaneously.



Save water

Ultra-sorb Model XV eliminates water waste and reduces airstream heat gain, energy costs, and boiler chemical use. Available for all pressurized steam applications.

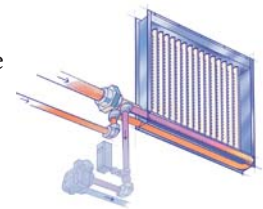

Optimize performance

DRI-STEEM's most advanced controller, Vapor-logic®4 continuously monitors space conditions to align humidifier output with demand. The result is accurate, responsive control.



Your DRI-STEEM representative is: